

**ECON Spring Return Actuator  
Fig. 7901 (metric) and 7951 (imperial)**



**ECON Double Acting Actuator  
Fig. 7902 (metric) and 7952 (imperial)**



Scan for manual

**Installation & Operation Manual for Pneumatic Actuator:  
Fig. 7901, 7902, 7951 and 7952**

<u>Content</u>	<u>Page</u>
1. ERIKS operating companies	2
2. Product description	2
3. Requirements for maintenance staff	4
4. Transport and storage	4
5. Function	4
6. Application	7
7. Installation	7
8. Maintenance	8
9. Recommended spare parts	12
10. Troubleshooting	20
11. Removal	21

## 1. ERIKS operating companies

ECON pneumatic actuators are being delivered by several ERIKS operating companies on a worldwide basis. In this manual these will be referred to as 'ERIKS', the individual terms of delivery of the ERIKS operating company having executed the order are applicable.

## 2. Product description

ECON Rack & Pinion actuators are available in both metric and imperial versions.

Metric versions with metric threaded connections and BSP air supply connections:

- Fig. 7901 – Single acting
- Fig. 7902 – Double acting

Imperial versions with imperial threaded connections and NPT air supply connections:

- Fig. 7951 – Single acting
- Fig. 7952 – Double acting

### ECON pneumatic actuators sizes 300 and smaller

These ECON pneumatic actuators have been designed and manufactured in accordance with the following European Directives requirements:

- European Pressure Equipment Directive 2014/68/EU: classified according to Article 3, Part 3, Cat. SEP must not carry the CE label.
- Machines Directive 78/392/EEC
- Directive 2014/34/EU ATEX, classification Group II, Cat. 2 for use in explosive atmospheres, Zones 1,2 & 21,22. Conformity evaluation according to Appendix VIII. Marking CE Ex II 2 G D c
- EN 15714-3 Pneumatic Part-Turn Actuators For Industrial Valves

Applied harmonized and non-harmonized Technical Standards:

- See ECON data sheets, technical brochure and assembly & maintenance procedures.
- UNE EN ISO 80079-36, UNE EN ISO 80079-37 constructive security – protection c, UNE EN 60079-0, EN 1127-1, Directive 1999/92/EC (2007/30/EC), Directive 2014/34/EU.

The electrical & mechanical accessories are not covered by this statement and will have to carry their own certificate in order to be assembled with the ECON pneumatic actuators.

ECON pneumatic actuators sizes 500 & larger

These ECON pneumatic actuators have been designed and manufactured in accordance with the following European Directives requirements:

- European Pressure Equipment Directive 2014/68/EU: classified according to Category I, Module A Evaluation Procedure of Conformity mod. A certified by the manufacturer ECON. Marking CE.
- Machines Directive 89/392/EEC.
- Directive 2014/634/EU ATEX, classification Group II, Cat. 2 for use in explosive atmospheres, Zones 1,2 & 21,22. Conformity evaluation according to Appendix VIII. Marking CE Ex II 2 G D c
- EN 15714-3 Pneumatic Part-Turn Actuators For Industrial Valves

Applied harmonized and non-harmonized technical Standards:

- See ECON data sheets, technical brochure and assembly & maintenance procedures.
- UNE EN ISO 80079-36, UNE EN ISO 80079-37 constructive security – protection c, UNE EN 60079-0, EN 1127-1, Directive 1999/92/EC (2007/30/EC), Directive 2014/34/EU.

The electrical and mechanical accessories are not covered by this statement and will have to carry their own certificate in order to be assembled with ECON pneumatic actuators.

The suitability of the materials and design of the actuator type in terms of its working conditions are the responsibility of the actuator's end user.

**DA & SR SIZES**

**DESCRIPTION OF THE PRESSURE EQUIPMENTS**

Fig.	Series	Size	PN (psi)
7902 7952 & 7901 7951	Double Acting and Spring Return	10	10 (145)
		20	8 (120)
		40	
		80	
		130	
		200	
300			

Fig.	Series	Size	PN (psi)
7902 7952 & 7901 7951	Double Acting and Spring Return	500	8 (120)
		850	
		1200	
		1750	
		2100	
		2500	
4000			

Material: Aluminium

Service conditions for standard actuators:

- Maximum Pressure: 8 bars (120 psi)  
(Except Fig. 7902 and 7952 type DA 10, 10 bars (145 psi))
- Minimum Temperature: -30 °C (-22 °F)
- Maximum Temperature: +100 °C (+212 °F)

Agreement evaluation process used: Category I Module A

Technical Standards & applied Specifications:

- Solenoid direct assembly according to Standard NAMUR VDI / VDE 3845
- Accessories assembly according to Standard NAMUR VDI / VDE 3845
- Connections to valves according to Standard EN ISO 5211

The ECON pneumatic actuators are designed according the information in our latest catalogue or see our website [www.eriks.com](http://www.eriks.com) and should be used in accordance with the applicable pressure-temperature rating as stated on this website. Pneumatic actuators are provided with marking, according to EN 19. The marking makes the identification of the pneumatic actuators easier and contains:

- CE marking if applicable

- ECON logo
- Direction of rotation
- Max. permissible supply pressure
- Type of actuator (double or single acting actuator)
- Number of springs for single acting execution
- Serial number
- Year and month of manufacturing
- Size and maximum supply pressure are shown on the end caps
- ISO 5211 flange connection dimensions

**3. Requirements for maintenance staff**

The staff assigned to assembly, operating and maintenance tasks should be qualified to carry out such jobs and in any circumstance, ensure personal safety.

**4. Transport and storage**

Transport and storage should always be protected against external forces, influence and destruction of the painting layer as well. The purpose of the painting layer is to protect the actuator against rust, during transport and storage. The actuator should be stored in an unpolluted space and should also be protected against all atmospheric circumstances. In order to prevent condensation formation care should be taken to control temperature and humidity of storage. All actuators must be examined upon delivery to ensure that they have not suffered any damage during transport. Inform the supplier immediately if there is any damage.

As standard, actuators will leave the factory in closed position. Open position configuration must be specially requested.

**WARNING!!**

Actuators must be stored under a cover and protected from inclement weather conditions and dampness with air conducts properly covered.

Actuators should not be unpacked until their definitive installation, except for inspection purposes.

**5. Function**

ECON pneumatic actuators are designed to open and close quarter turn valves by air.

**5.1 APPLICABLE RANGE**

The Pneumatic Actuators ECON uses a rack and pinion sliding system that creates a linear torque with a quarter turn operation. The range is the following:

<b>Fig. 7901 Spring Return</b>	<b>SPRING COMBINATIONS</b>					
SR-20	S04	S06	S08			
SR-40	S04	S06	S08	S10	S12	S14
SR-80	S04	S06	S08	S10	S12	S14
SR-130		S06	S08	S10	S12	S14
SR-200		S06	S08	S10	S12	S14
SR-300		S06	S08	S10	S12	S14
SR-500		S06	S08	S10	S12	S14
SR-850		S06	S08	S10	S12	S14
SR-1200		S06	S08	S10	S12	S14
SR-1750		S06	S08	S10	S12	S14
SR-2100		S06	S08	S10	S12	S14
SR-2500		S06	S08	S10	S12	S14
SR-4000		S06	S08	S10	S12	S14

<b>Fig. 7902</b> <i>Double Acting</i>
DA-10
DA-20
DA-40
DA-80
DA-130
DA-200
DA-300
DA-500
DA-850
DA-1200
DA-1750
DA-2100
DA-2500
DA-4000

**5.2 SPRING COMBINATION BY TYPE OF ACTUATOR**

ECON actuators use a maximum of seven springs on each side, always using a same type of spring independently of the combination of springs that will be used.

The quantity of springs is identified as follows:

- e.g.: S14
- S = springs & 14 is the total number of springs assembled in the actuator.

**5.2.1. ACTUATOR SIZE 7901-SR-20 and 7951-SR-20**

The actuator SR-20 uses a minimum of 2 springs and a maximum of 4 springs on each side, according to the diagrams below, depending on the springs combination that require to be assembled.



**5.2.2. ACTUATORS SIZES 7901-SR-40&80 and 7951-SR-40&80**

The actuators SR-40 & 80 use a minimum of 2 springs and a maximum of 7 springs on each side, according to the diagrams below, depending on the springs combination that require to be assembled.

**5.2.3. ACTUATORS SIZES 7901-SR-130 ~ 4000 and 7951-SR-130 ~ 4000**

The actuators SR-130 ~ 4000 use a minimum of 3 springs and a maximum of 7 springs on each side, according to the diagrams below, depending on the springs combination that require to be assembled.



**6. Application**

ECON pneumatic actuators are widely used for operation of quarter turn valves. The pneumatic actuators are designed for standard operating conditions. For use in extreme conditions e.g. aggressive or corrosive environments, it is recommended to mention this at the ordering stage, in order to verify if the actuator is suitable. The installation designer is responsible for the pneumatic actuator selection and must determine if the actuator is suitable for the working conditions. The pneumatic actuators are unsuitable, without written permission of an ERIKS company, to apply for hazardous media as referred into Regulation (EC) No 1272/2008.

**7. Installation**

7.1 The handling and transportation of actuators must be carried out with extreme precaution and using the necessary and adequate means depending on their size and weight in order to avoid risks to the operators handling them.

**WARNING!!**

Check the physical conditions of actuators in order to detect any damage incurred during transport and/or handling.

7.2 Actuators should be installed in such a way that they are easy to access in order to do the periodic inspections and corresponding maintenance operations necessary to guarantee the performance qualities that they have been designed for.

**WARNING!!**

Actuators must not support unexpected stress. It is important to do the assemble with a correct alignment and parallelism to guarantee that it is not submitted to unexpected stress.

**IMPORTANT!!**

After the installation carry out a final operational check of the actuator by making some opening and closing operations to ensure that it works properly.

The use of dry air increases the lifetime of the actuators, as well as the lifetime of their accessories, solenoids and other pneumatic accessories.

**7.3 RECOMMENDED MINIMUM AIR QUALITY**

For best possible service life and trouble-free operation, ISO 8573-1 quality class 5.4.4 should be used. This means a 40 µm (1570 µin) filter, dew point +3 °C (37.4 °F) for indoor operation (a lower dew point should be selected for outdoor operation, Quality class 3) and oil concentration 5 mg/m<sup>3</sup> (3.92 ppm)

Quality class	Pollution				Water		Oil	
	Particle size		Max. concentration		Max. press. dew point		Max. concentration	
	µm	µin	mg/m <sup>3</sup>	ppm	°C	°F	mg/m <sup>3</sup>	ppm
1	0,1	3.94	0,1	0.0783	-70	-94	0,01	0.00783
2	1	39.4	1	0.783	-40	-40	0,1	0.0783
3	5	197	5	3.92	-20	-4	1	0.783
4	15	591	8	6.27	3	37.4	5	3.92
5	40	1570	10	7.83	7	44.6	25	19.6
6	-	-	-	-	10	50	-	-

#### 7.4 Lubrication

Actuators are factory lubricated for the lifetime in normal working conditions.

The standard lubricant is suitable for use from -30 °C (-22 °F) up to 100 °C (212 °F).

For low and high temperature execution, where special grease is required please contact your distributor.

For our standard execution we recommend to use Molicote B2.2 Plus grease or similar

#### WARNING!!

Actuators are lubricated during assembly and do not require any further lubrication.

#### 7.5 Make sure that both the actuator and valve are in the same position, open or closed.

#### 7.6 When assembling the actuator on the valve, check their alignment to ensure that the coupling is properly aligned between the valve and the actuator.

#### 7.7 The coupling bolts, whether the actuator connects directly to the valve or uses a bracket, must be tightened proportionally, distributing the stress, before tightening them completely

#### 7.8 The normal performance of the actuators is to close clockwise and to open counter clockwise. However, this may be inverted under request.

#### 7.9 ECON pneumatic actuators are provided with bi-directional pinion travel stops. Side located stops allow a full $\pm 5^\circ$ travel adjustment between $85^\circ$ and $95^\circ$ . Adjustment of the counter clockwise and clockwise rotation limits is accomplished by unscrewing the locking nuts. 1/3 turn of those locking nuts equals $1^\circ$ of rotation of valve.

#### WARNING!!

Do not adjust more than  $2.5^\circ$  each side, designed by the manufacturer. Internal parts could be damaged.

#### IMPORTANT!!

It is advisable to operate the actuator twice before fully tightening the coupling bolts in order to ensure a good centring.

## **8 Maintenance**

### 8.1 PREVENTIVE MAINTENANCE

8.1.1 This basically consists in a periodic inspection to check the actuator function.

8.1.2 Actuators must be operated at least once every six months. However, depending on the application of the actuator, this may be done within shorter periods.

8.1.3 It is the end user's responsibility to establish these operation plans depending on the working conditions.

#### WARNING!!

Never leave the actuators opened or closed during a long period of time.

8.1.4 It is recommended to replace O-rings, guides and washers when an in-depth revision of the installation is made.



## 8.2 MAINTENANCE OPERATIONS

### 8.2.1 PRECAUTIONS BEFORE DISASSEMBLY!!

- 8.2.1.1 Disconnect the actuator and its accessories from the air and electrical network.
- 8.2.1.2 Disassemble the solenoid from the actuator.
- 8.2.1.3 Disassemble the actuator from the valve and/or from its couplings.

#### WARNING!!

Always wear adequate protective clothing (Follow the safety guidelines established by your company!)

Any parts replacement should be done with the original ECON spare parts!!

The manufacturer will not be responsible of the wrong functioning of the actuator if original ECON parts have not been used.

## 8.3 REASONS FOR PARTS REPAIR AND REPLACEMENT

Parts of the actuator will have to be repaired or replaced as soon as leakage is detected through the upper O-ring (111) or lower O-ring (110) of the pinion, through the O-ring (109) of the piston or through the O-rings (118) of the end caps.

As soon as this happens, proceed with the disassembly of the actuator and replacement of all the O-rings, bushings, slide guides and washers as listed in the spares parts.

## 8.4 DISASSEMBLY OF THE ACTUATOR

Once the precautions prior to the disassembly have been taken, follow the next steps:

- 8.4.1 Disassemble the end caps (4) of the actuator by un-tightening the external bolts (113).

#### WARNING!!

With SPRING RETURN ACTUATORS there is no danger during this operation as the fastening bolts of the caps are designed with adequate length to absorb spring stress

- 8.4.2 Unfasten the nuts (934) in order to remove the levelling screws (16).
- 8.4.3 Turn the pinion (3) counter clockwise to disengage the pistons (2) in normally closed actuators and clockwise in normally open ones. Remove the pistons from the cylinder.
- 8.4.4 Disassemble the position indicator (20), the degree indicator (24), the slip washer (471), the soft pinion washer (5) and the metallic pinion washer (8) from the upper side.
- 8.4.5 Disassemble the pinion (3) from the lower part of the body (1) of the actuator. To do this operation, disassemble the upper pinion bearing (10) and the stop (12) through the inside of the body.
- 8.4.6 Clean all the parts of the actuator.
- 8.4.7 Examine all the parts in order to see if there is any wear due to over-use.

#### WARNING!!

Carefully examine the inside of the cylinder.

8.4.8 If everything is in good conditions, replace the O-rings, bushings, slide guides included in the ECON Maintenance kits, before reassembling the actuator.

8.4.9 Lubricate the parts of the actuator with Molicote B 2-2 plus grease. Apply a thin layer of grease on the O-rings (109, 110 & 111).

## 8.5 ASSEMBLY OF THE ACTUATOR

After the disassembly, the inspection and lubrication of the different parts proceed to the assembly following the sequence below:

8.5.1 Correctly assemble all the parts included in ECON Maintenance kits previously lubricated.

8.5.2 Place the pinion (3) in the body's (1) actuator from underneath. Once the pinion appears through the inside of the body, assemble the pinion stop (12) in its correct position and the upper pinion bearing (10).

8.5.3 Place the soft pinion washer (5), the metallic pinion washer (8), the slip washer (471), the degree indicator (24) and the position indicator (20) in the upper part of the pinion.

8.5.4 Assemble both pistons, checking that they engage at the same time when turning the pinion (3) clockwise for normally closed actuators and counter clockwise for normally open actuators.

8.5.5 Assemble actuators end caps (4) tighten the bolts (113) equally corner to corner.

8.5.6 Check that the open and closed positions coincide with the position indicated in the upper part of the pinion, then assembly the cover.

**IMPORTANT!!** Once the assembly is done, operate the actuator a few times

*Closed Position*

*Open Position*



Fig.7902-DA-10

**PIPE AXIS**

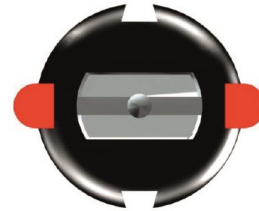

Size 20 to 850

**PIPE AXIS**

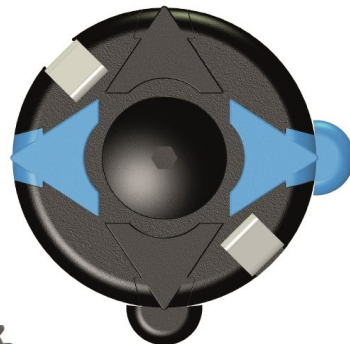
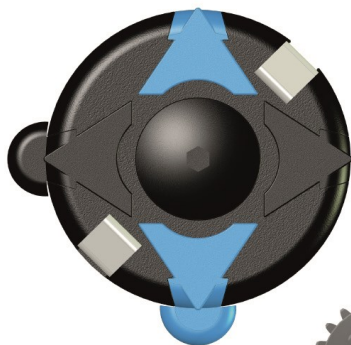

Size 1200 to 4000

**PIPE AXIS**

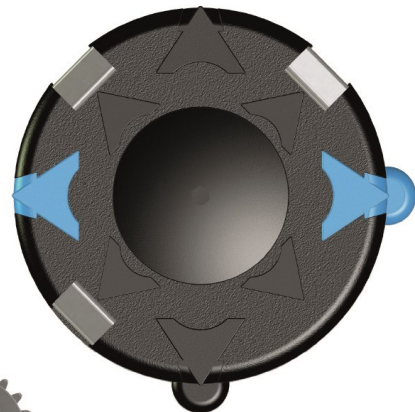
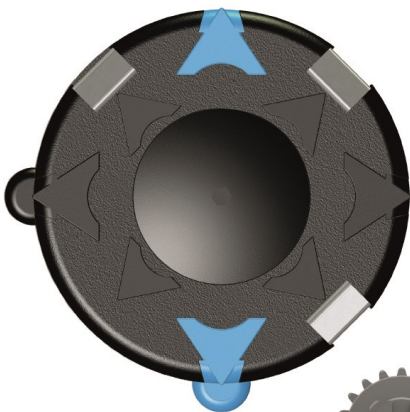

**9 Recommended Spare Parts**

The spare parts kit of the Fig.7901, 7902, 7951 and 7952 actuator consists of the following parts:

<i>Nº</i>	<i>Quantity</i>	<i>Name</i>
5	1	Soft Pinion Washer
6	2 or 4 *	Slide Piston
8	1	Metallic Pinion Washer
10	1	Upper Pinion Bearing
24	2	Rubber Plug
25	2	Slide Guide
26	1	Lower Pinion Bearing
109	2	Piston's O-ring
110	1	Lower Pinion's O-ring
111	1	Upper Pinion's O-ring
118	2	Cap's O-ring
119	2	O-ring
471	1	Slip Washer

\*Size 10 to 1750 = 2, Size 2100 to 4000 = 4

**9.2 EXPLODED VIEW ECON ACTUATOR, Fig.7902-DA-10 and 7952-DA-10**

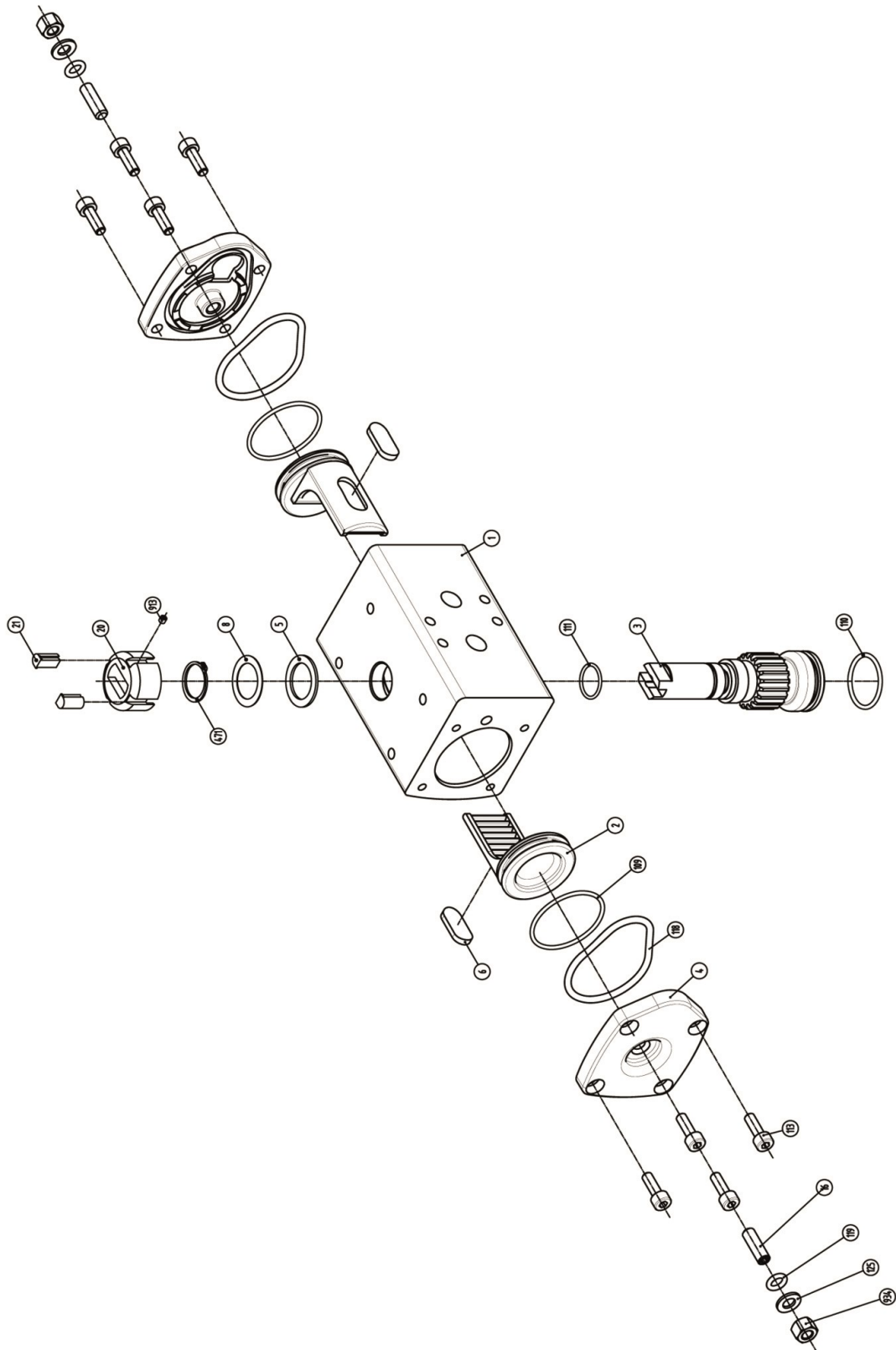

**9.3 EXPLODED VIEW ECON ACTUATOR, Fig.7902-DA-20 ~ 850 and 7952-DA-20 ~ 850**

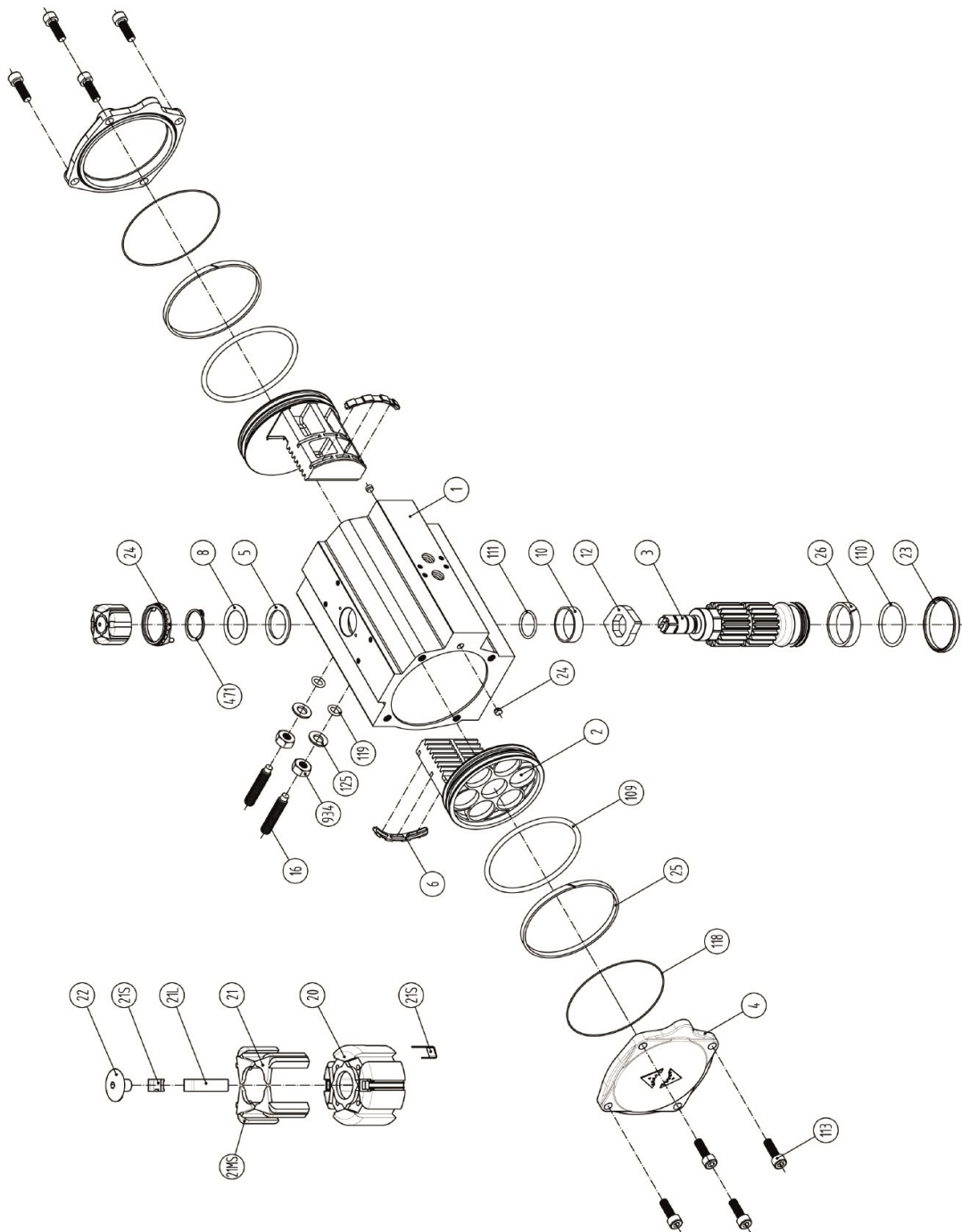

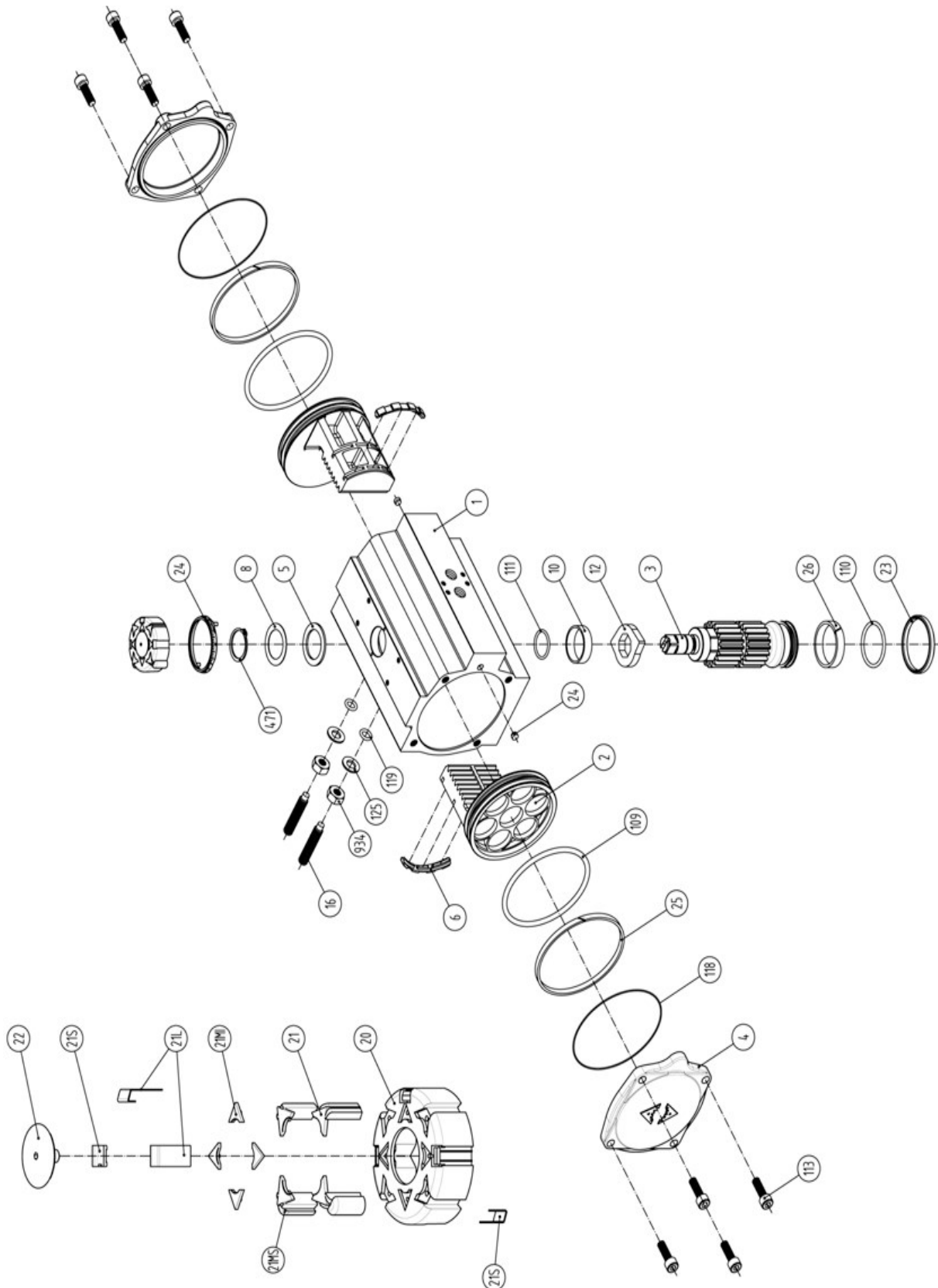

**9.5 EXPLODED VIEW ECON ACTUATOR, Fig.7902-DA-1200 ~ 2100 and 7952-DA-1200 ~ 2100**



**9.6 EXPLODED VIEW ECON ACTUATOR, Fig.7901-SR-1200 ~ 2100 and 7951-SR-1200 ~ 2100**

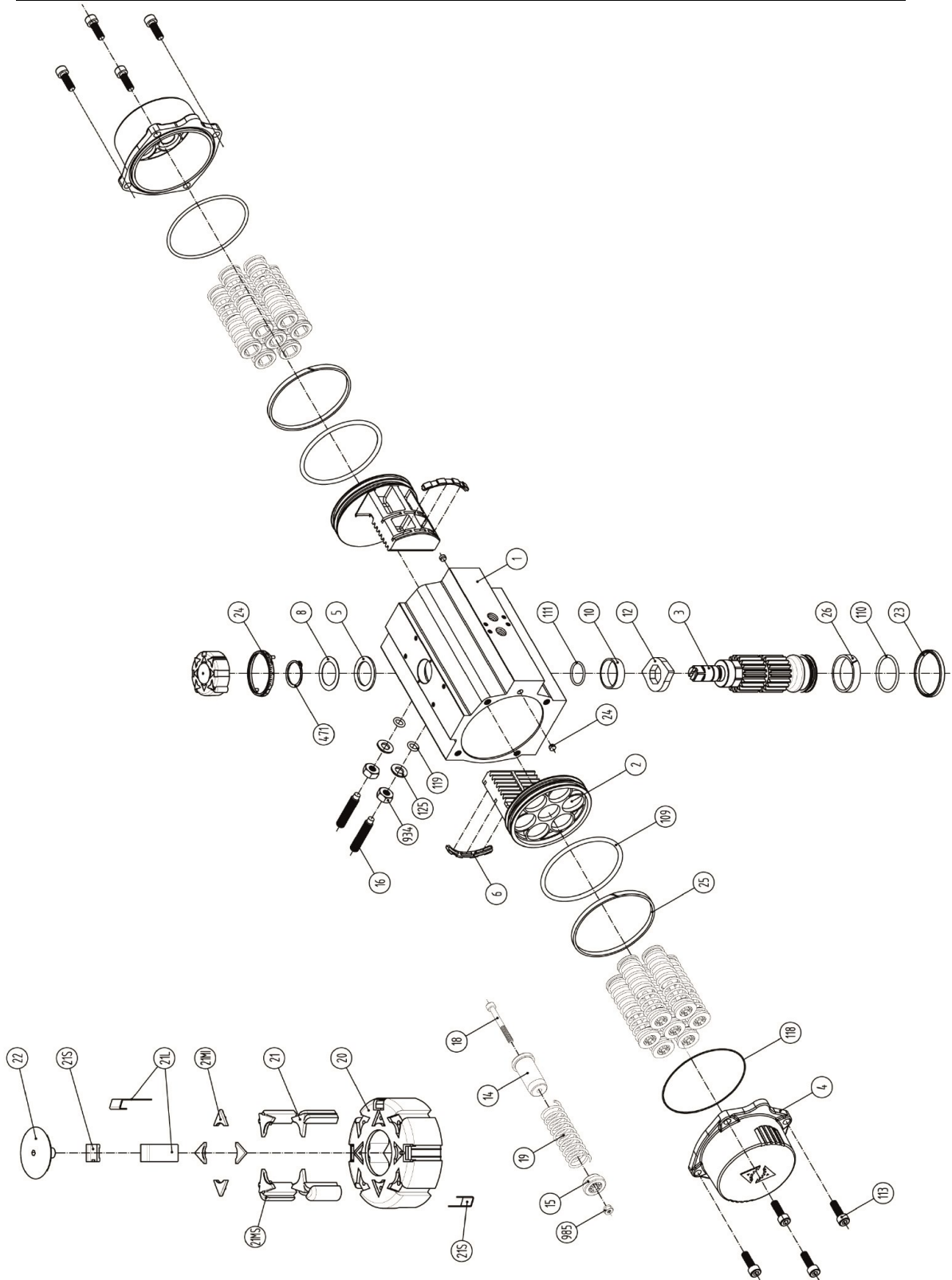

**9.7 EXPLODED VIEW ECON ACTUATOR, Fig.7902-DA-2500 ~ 4000 and 7952-DA-2500 ~ 4000**

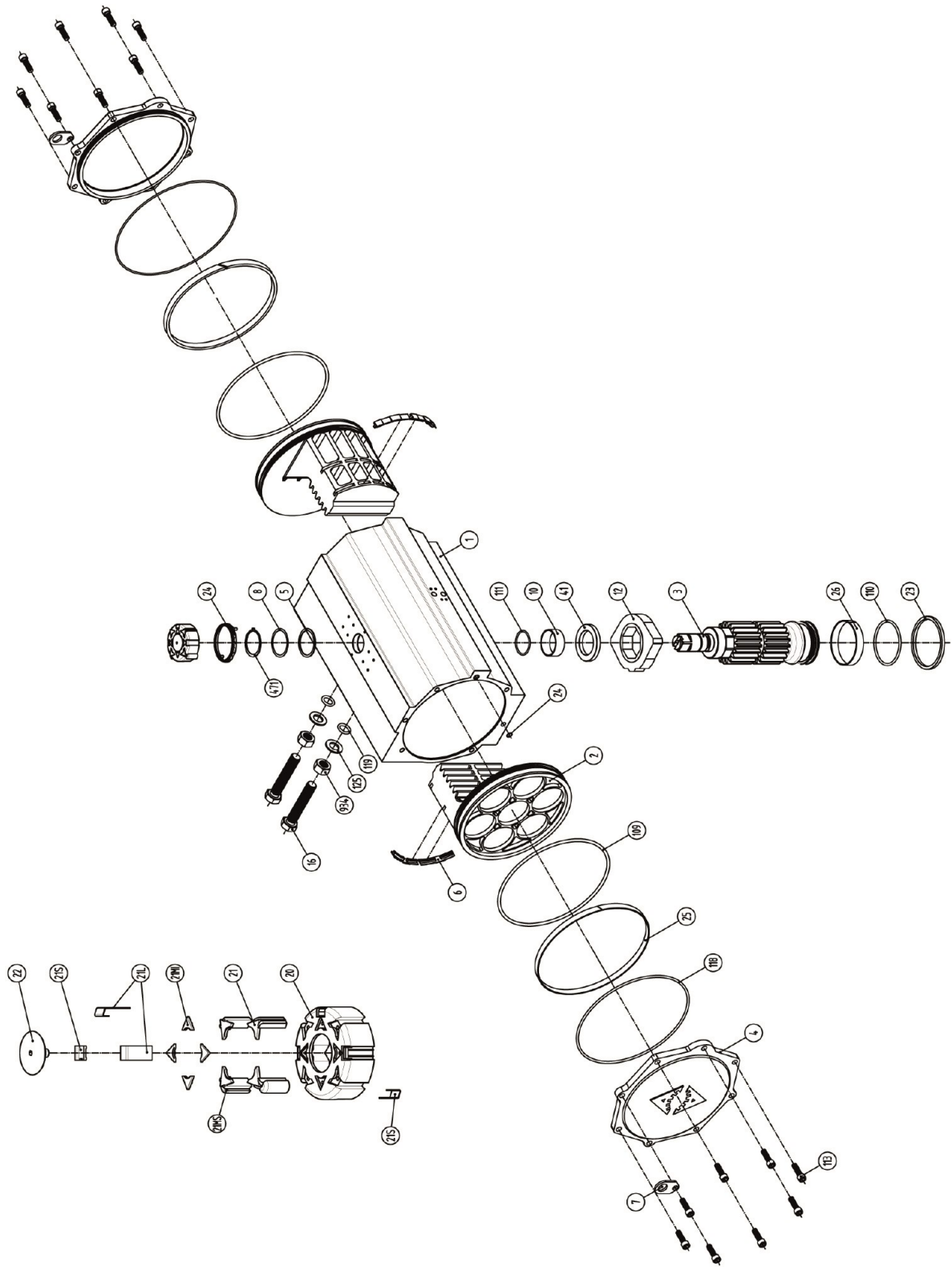

**9.8 EXPLODED VIEW ECON ACTUATOR, Fig.7901-SR-2500 ~ 4000 and 7951-SR-2500 ~ 4000**

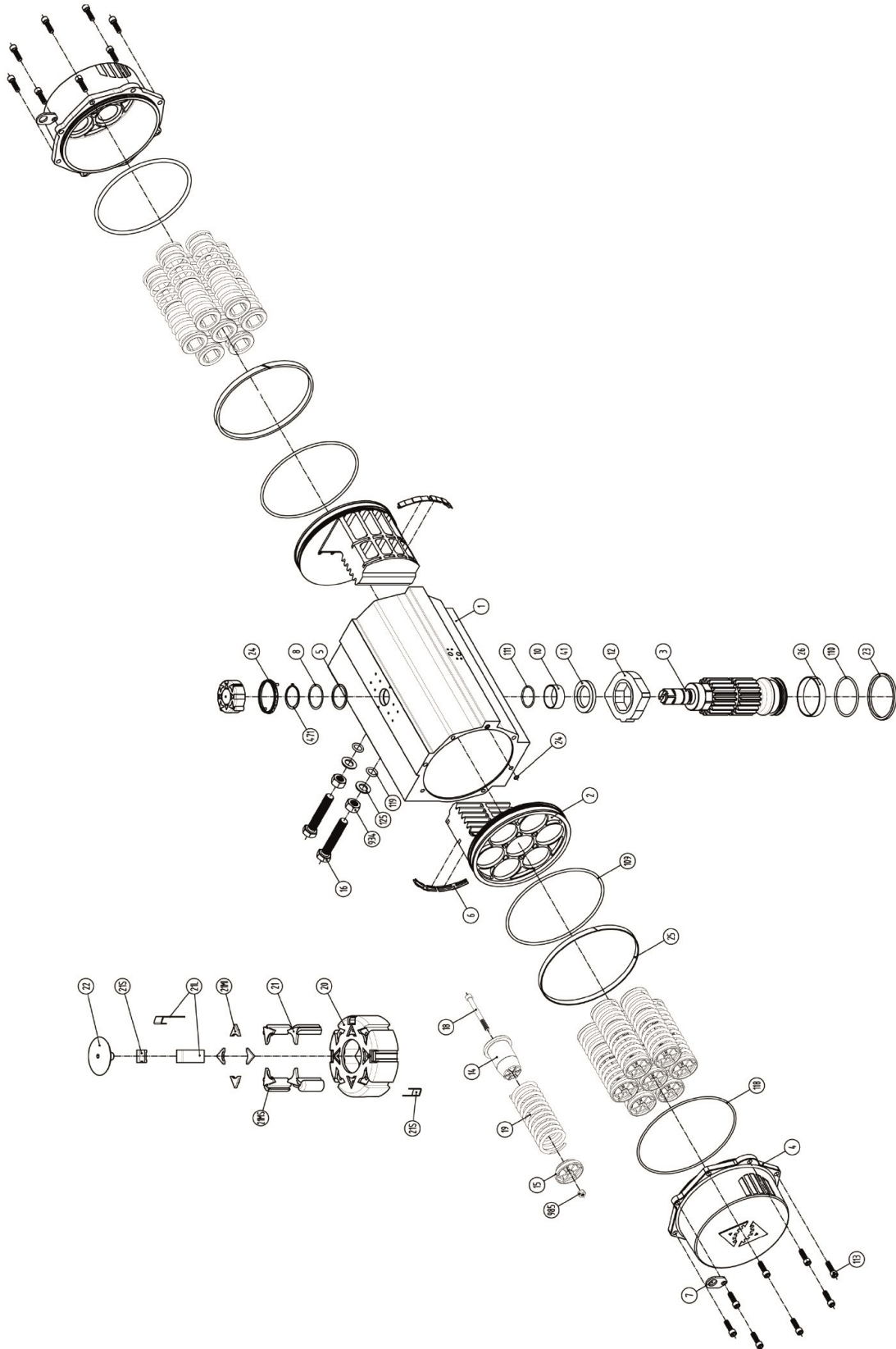

## 10 **Troubleshooting**

It is essential that the safety regulations are observed when identifying the fault.

### WARNING!!

Before disassembling the actuator, follow the instructions given below:

### 10.1 **Actuator with solenoid valve**

A. If the actuator does not function check the following:

1. The valve is free to rotate.
2. The actuator is of the correct size.
3. The correct voltage is supplied to the solenoid (the valve coil is tagged with the correct voltage).
4. Sufficient compressed air is supplied to the solenoid valve.

B. If the proper voltage and air pressure have been verified and the valve is free to move proceed as follows:

1. Apply the correct voltage to the solenoid valve. Check for a clicking sound.
2. If sound is not detected:
  - I) Carefully unscrew the solenoid and solenoid stem from the block.
  - II) Re-apply voltage and observe the solenoid plunger. If it does not retract replace the solenoid valve.
3. If the solenoid functions, remove both the solenoid and the mounting block for testing. Connect with a minimum 3 barg (43.5 psig) air supply and correct voltage. Switch it on off and check the air flow. Air should flow out of only one outlet port when the solenoid is energised.

C. If the actuator functions but exhibits leak or power loss accompanied by leakage proceed as follows:

1. Check the voltage. It must be within 10% of the specified voltage.
2. Check compressed air supply. Ensure that no intense pressure drops occur as the unit is cycled. Loss of pressure can cause incomplete shifting of the spool valve in the block or at one of the piston seals of the actuator. A leaking piston seal will usually leak on either cycle, on spring return actuators, piston seal leakage will show at port B on the air manifold flange. A leaking spool valve will require replacing. Leaking piston seals can be restored by replacing the "O" rings with new ones.

### 10.2 **Actuator without a solenoid valve.**

For actuators without solenoid valve, (or those where the solenoid valve and mounting block are working correctly), remove the actuator from the valve, disassemble and check the following:

1. Make sure all porting is clear of obstructions.
2. Make sure that the actuator is lubricated and that there is no solidified grease between the pinion and piston racks. If solidified grease is present, clean, dry, regrease and reassemble.
3. Verify that the actuator pinion shaft and / or pistons are not seized. If seized, reassemble as per instructions in section 8.
4. If the unit exhibits excessive backlash, check the teeth on the piston racks for wear.
5. With spring return actuators, check for misplaced or broken springs. If spring is broken check the body for scoring.
6. If the actuator and valve are free reassemble the actuator and retest. If the unit still fails to operate, contact your distributor.

## 11 Removal

All dismantled and rejected valves cannot be disposed with household waste. The valves are made of materials which can be re-used and should be delivered to designated recycling centres.

### General warning:

#### General note for products which may be used for seawater:

Although our products can be used in seawater systems it should always be noted that, in case of installation in a piping system made of materials which are frequently used because of their excellent seawater resistance (e.g. Cunifer), large potential differences may occur possibly causing corrosion which could permanently damage the proper functioning and integrity of our product.

A combination of different materials should always be mentioned prior to the purchase of our products in order for us to give the best possible advice on a safe functioning.

#### General note for cast iron products:

Cast iron can be used for various applications, such as listed in our catalogue. It should however always be observed, that frost (in combination with non drained products) may permanently damage the proper functioning and integrity of our product.